

PC1500

Size: AA (LR6)

Alkaline-Manganese Dioxide Battery

Zn/MnO₂



Dimensions shown are IEC standards

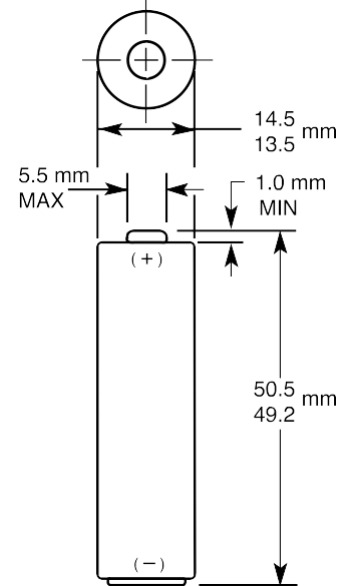

| | |
|-----------------------------|--|
| Nominal voltage | 1.5 V |
| Impedance | 120 m-ohm @ 1 kHz |
| Typical weight | 24 g (0.8 oz) |
| Typical volume | 8.4 cm ³ (0.5 in ³) |
| Terminals | Flat |
| Storage temperature range | 5°C to 30°C (41°F to 86°F) |
| Operating temperature range | -20°C to 54°C (-4°F to 130°F) |
| Designation | IEC: LR6 |

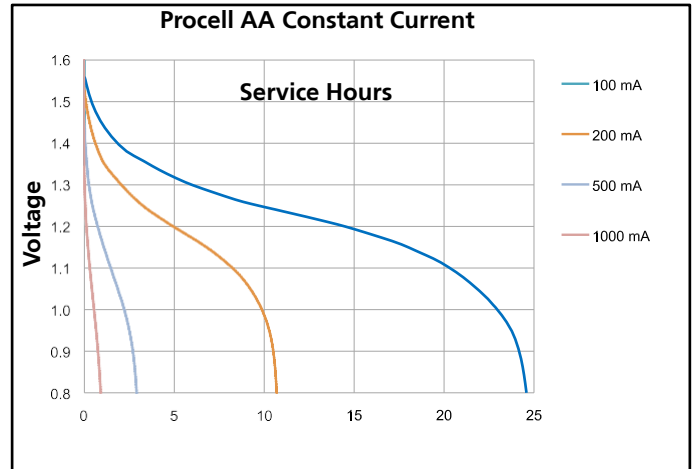
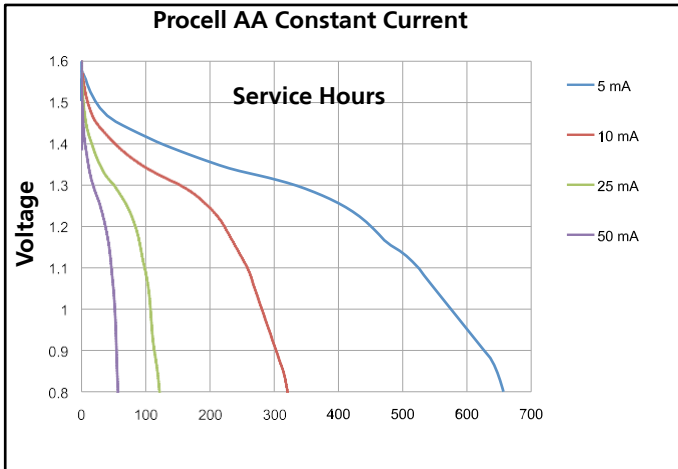

DURACELL
BATTERIES

Berkshire Corporate Park
Bethel, CT. 06801 U.S.A.
Telephone: Toll-free 1-800-544-5454
www.duracell.com

Delivered capacity is dependent on the applied load, operating temperature and cut-off voltage. Please refer to the charts and discharge data shown for examples of the energy/service life that the battery will provide for various load conditions.

PC1500

Size: AA (LR6)

Alkaline-Manganese Dioxide Battery

Zn/MnO₂

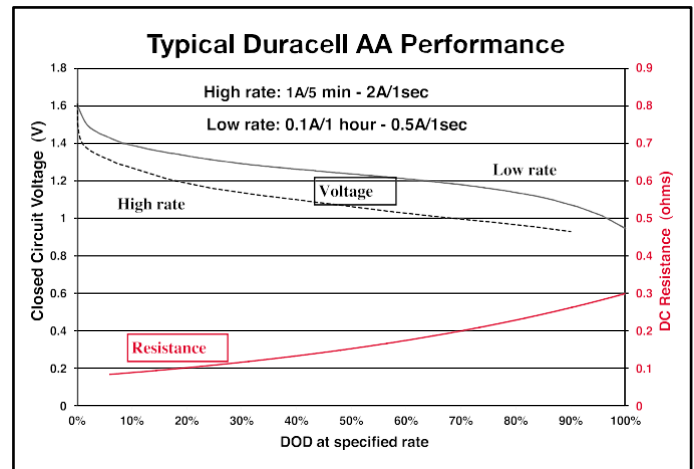
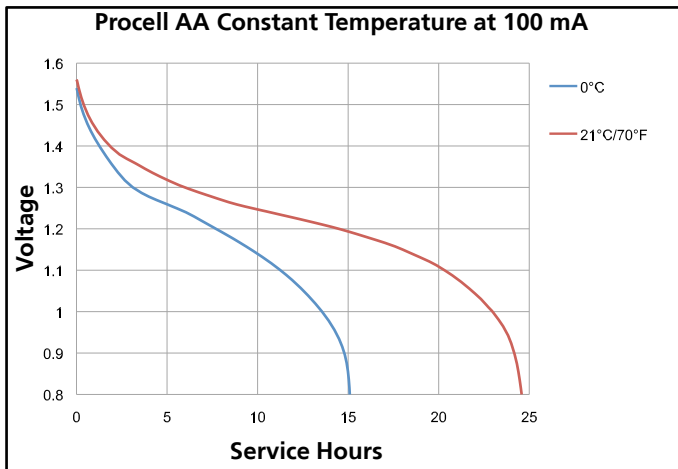
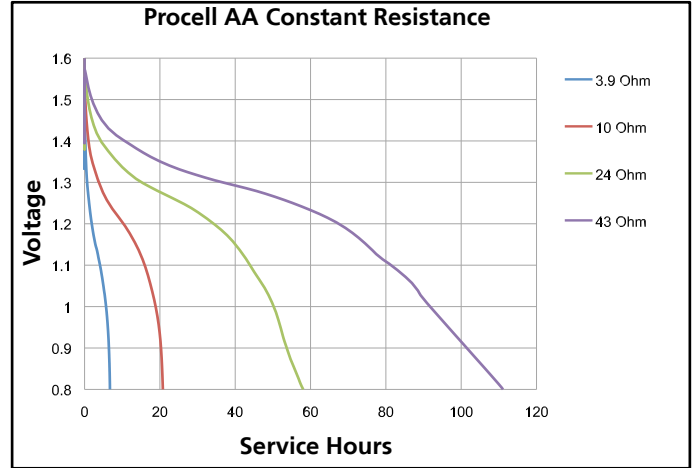
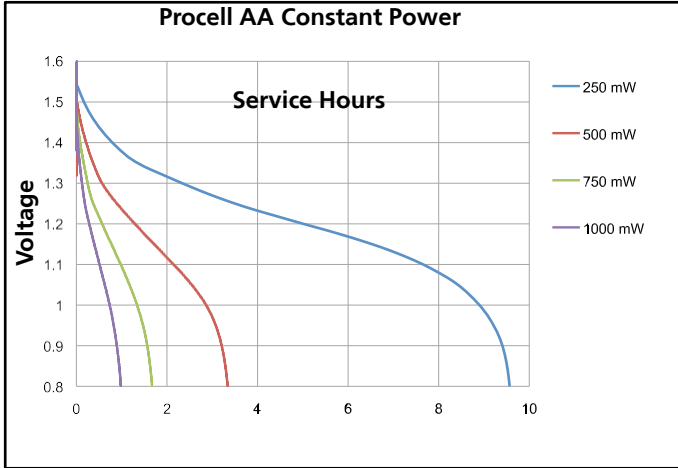

DURACELL®
BATTERIES

Berkshire Corporate Park
Bethel, CT. 06801 U.S.A.
Telephone: Toll-free 1-800-544-5454
www.duracell.com

Delivered capacity is dependent on the applied load, operating temperature and cut-off voltage. Please refer to the charts and discharge data shown for examples of the energy/service life that the battery will provide for various load conditions.